



Ice Maker
Model IC-CN-0016
Item 37865
Instruction Manual



Revised - 05/05/2022



Toll Free: 1-800-465-0234
Fax: 905-607-0234
Email: service@omcan.com
www.omcan.com

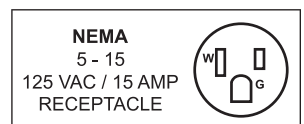

Table of Contents

Model IC-CN-0016

Section	Page
Disclaimer -----	3
General Information -----	4 - 5
Safety and Warranty -----	5 - 7
Technical Specifications -----	8
Installation -----	9 - 13
Operation -----	14 - 16
Maintenance -----	17 - 20
Troubleshooting -----	20 - 22
Parts Breakdown -----	23 - 24
Electrical Schematics -----	25
Notes -----	26
Warranty Registration -----	27

OMCAN IS NOT RESPONSIBLE FOR ANY DAMAGES DUE TO WATER LEAKS. WARRANTY FOR WATER LEAKS IS VOID IF THE WICKING PAD IS NOT REPLACED EVERY SIX MONTHS, AND IF THE AMBIENT ROOM TEMPERATURE EXCEEDS 75°F AND 55% RELATIVE HUMIDITY, AND THE APPLIANCE DRAIN IS NOT CONNECTED DIRECTLY TO THE FLOOR DRAIN.

General Information

Omcan Manufacturing and Distributing Company Inc., Food Machinery of America, Inc. dba Omcan and Omcan Inc. are not responsible for any harm or injury caused due to any person's improper or negligent use of this equipment. The product shall only be operated by someone over the age of 18, of sound mind, and not under the influence of any drugs or alcohol, who has been trained in the correct operation of this machine, and is wearing authorized, proper safety clothing. Any modification to the machine voids any warranty, and may cause harm to individuals using the machine or in the vicinity of the machine while in operation.

CHECK PACKAGE UPON ARRIVAL

Upon receipt of an Omcan shipment please inspect for external damage. If no damage is evident on the external packaging, open carton to ensure all ordered items are within the box, and there is no concealed damage to the machine. If the package has suffered rough handling, bumps or damage (visible or concealed), please note it on the bill of lading before accepting the delivery and contact Omcan within 24 hours, so we may initiate a claim with the carrier. A detailed report on the extent of the damage caused to the machine must be filled out within three days, from the delivery date shown in the shipping documents. Omcan has no recourse for damaged products that were shipped collect or third party.

Before operating any equipment, always read and familiarize yourself with all operation and safety instructions.

Omcan would like to thank you for purchasing this machine. It's of the utmost importance to save these instructions for future reference. Also save the original box and packaging for shipping the equipment if servicing or returning of the machine is required.

Omcan Fabrication et distribution Compagnie Limitée et Food Machinery d'Amérique, dba Omcan et Omcan Inc. ne sont pas responsables de tout dommage ou blessure causé du fait que toute personne ait utilisé cet équipement de façon irrégulière. Le produit ne doit être exploité que par quelqu'un de plus de 18 ans, sain d'esprit, et pas sous l'influence d'une drogue ou d'alcool, qui a été formé pour utiliser cette machine correctement, et est vêtu de vêtements de sécurité appropriés. Toute modification de la machine annule toute garantie, et peut causer un préjudice à des personnes utilisant la machine ou des personnes à proximité de la machine pendant son fonctionnement.

VÉRIFIEZ LE COLIS DÈS RÉCEPTION

Dès réception d'une expédition d'Omcan veuillez inspecter pour dommages externes. Si aucun dommage n'est visible sur l'emballage externe, ouvrez le carton afin de s'assurer que tous les éléments commandés sont dans la boîte, et il n'y a aucun dommage dissimulé à la machine. Si le colis n'a subi aucune mauvaises manipulations, de bosses ou de dommages (visible ou cachée), notez-le sur le bond de livraison avant d'accepter la livraison et contactez Omcan dans les 24 heures qui suivent, pour que nous puissions engager une réclamation auprès du transporteur. Un rapport détaillé sur l'étendue des dommages causés à la machine doit être rempli dans un délai de trois jours, à compter de la date de livraison indiquée dans les documents d'expédition. Omcan n'a aucun droit de recours pour les produits endommagés qui ont été expédiés ou cueilli par un tiers transporteur.



General Information

Avant d'utiliser n'importe quel équipement, toujours lire et vous familiariser avec toutes les opérations et les consignes de sécurité.

Omcan voudrais vous remercier d'avoir choisi cette machine. Il est primordial de conserver ces instructions pour une référence ultérieure. Également conservez la boîte originale et l'emballage pour l'expédition de l'équipement si l'entretien ou le retour de la machine est nécessaire.

Omcan Empresa De Fabricacion Y Distribucion Inc. Y Maquinaria De Alimentos De America, Inc. dba Omcan y Omcan Inc. no son responsables de ningun daño o perjuicio causado por cualquier persona inadecuada o el uso descuidado de este equipo. El producto solo podra ser operado por una persona mayor de 18 años, en su sano juicio y no bajo alguna influencia de droga o alcohol, y que este ha sido entrenado en el correcto funcionamiento de esta máquina, y ésta usando ropa apropiada y autorizada. Cualquier modificación a la máquina anula la garantía y puede causar daños a las personas usando la máquina mientras esta en el funcionamiento.

REVISE EL PAQUETE A SU LLEGADA

Tras la recepcion de un envio Omcan favor inspeccionar daños externos. Si no hay daños evidentes en el empaque exterior, Habra el carton para asegurarse que todos los articulos solicitados estén dentro de la caja y no encuentre daños ocultos en la máquina. Si el paquete ha sufrido un manejo de poco cuidado, golpes o daños (visible o oculto) por favor anote en la factura antes de aceptar la entrega y contacte Omcan dentro de las 24 horas, de modo que podamos iniciar una reclamación con la compañía. Un informe detallado sobre los daños causados a la máquina debe ser llenado en el plazo de tres días, desde la fecha de entrega que se muestra en los documentos de envío. Omcan no tiene ningun recurso por productos dañados que se enviaron a recoger por terceros.

Antes de utilizar cualquier equipo, siempre lea y familiarizarse con todas las instrucciones de funcionamiento y seguridad.

Omcan le gustaría darle las gracias por la compra de esta máquina. Es de la mayor importancia para salvar estas instrucciones para futuras consultas. Además, guarda la caja original y el embalaje para el envío del equipo si servicio técnico o devolución de la máquina que se requiere.

Safety and Warranty

IMPORTANT SAFEGUARDS

How to Connect Electricity

For personal safety, this appliance must be properly grounded.

- A standard electrical supply, properly grounded in accordance with the National Electrical Code and Local codes and ordinances is required.
- Please make sure that the unit is properly grounded by a qualified technician.

Safety and Warranty

- Have the wall outlet and circuit checked by a qualified electrician to make sure the outlet is properly grounded.
- Do not kink or pinch the power supply cord.
- It is recommended that a separate circuit, serving only your ice maker, be provided.
- Use receptacles that cannot be turned off by a switch or pull chain.
- Do not connect or disconnect the electric plug when your hands are wet.
- Unplug the ice maker or disconnect power before cleaning or servicing. Failure to do so can result in electrical shock or death.
- Never unplug your ice maker by pulling on the power cord. Always grip plug firmly and pull straight out from the outlet.
- Repair or replace immediately all power cords that have become frayed or otherwise damaged. Do not use a cord that shows cracks or abrasion damage along its length or at either end.
- When moving the ice maker away from the wall, be careful not to roll over damage the power cord.

Proper Disposal of the Ice maker

- Choose a well-ventilation area with temperatures above 50°F and below 100°F. This unit must be installed in an area protected from the elements, such as wind, rain, water spray or drips.
- To ensure proper ventilation for your ice maker, the front of the unit must be completely unobstructed.
- The machine should not be located next to ovens, grills or other sources of high heat.
- It is important for the ice maker to be leveled in order to work properly. You may need to make several adjustments to level it.
- Never allow children to operate, play with or crawl inside the ice maker.
- Never clean ice maker parts with flammable fluids. These fumes can create a fire hazard or explosion.
- Do not store or use gasoline or other flammable vapors and liquids in the vicinity of this or any other appliance. The fumes can create a fire hazard or explosion.
- Do not put anything inside the ice maker cabinet and ice storage bin.
- Turn on the water supply tap before switch on the ice maker. Never turn the water supply tap off when the ice maker is working.
- Never touch the evaporator surface by hand when the ice maker is working. Otherwise it may hurt your hands.
- This appliance is not intended for use by persons (including children) with reduced physical, sensory or mental capabilities or lack of experience and knowledge, unless they have been given supervision or instruction concerning use of the appliance by person responsible for their safety.

Safety Alert Symbols

Your safety and the safety of others are very important. We have provided many important safety messages in this manual and on your appliance. Always read and obey all safety messages.



This is the safety alert symbol. This symbol alerts you to potential hazards that can kill or hurt you and others. All safety messages will follow the safety alert symbol and either the word “DANGER” “WARNING” or “CAUTION”, these words mean:

Safety and Warranty

⚠ DANGER ⚠

Danger means that failure to follow this safety statement may result in severe personal injury or death.

⚠ WARNING

Warning means that failure to follow this safety statement may result in extensive product damage, serious personal injury, or death.

CAUTION

Caution means that failure to follow this safety statement may result in minor or moderate personal injury, property or equipment damage.

All safety messages will tell you what the potential hazard is, tell you how to reduce the chance of injury, and tell you what can happen if the instructions are not followed.

RESIDENTIAL USERS: Vendor assumes no liability for parts or labor coverage for component failure or other damages resulting from installation in non-commercial or residential applications. The right is reserved to deny shipment for residential usage; if this occurs, you will be notified as soon as possible.

1 YEAR PARTS AND LABOUR BENCH WARRANTY

Within the warranty period, contact Omcan Inc. at 1-800-465-0234 to schedule an Omcan authorized service technician to repair the equipment locally.

Unauthorized maintenance will void the warranty. Warranty covers electrical and part failures, not improper use.

Please see <https://omcan.com/disclaimer> for complete info.

WARNING:

The packaging components are classified as normal solid urban waste and can therefore be disposed of without difficulty.

In any case, for suitable recycling, we suggest disposing of the products separately (differentiated waste) according to the current norms.

DO NOT DISCARD ANY PACKAGING MATERIALS IN THE ENVIRONMENT!

Technical Specifications

Model	IC-CN-0016
Max. Production	120 lbs. / 54 kgs. per day
Max. Ice Storage	35 lbs. / 16 kgs.
Ice Shape	Cube
Electrical	115V / 60Hz / 1
Power	560 W
Current	7.5A - 11.8A
Refrigerant	R134a, 240g
Weight	110.3 lbs. / 50 kgs.
Packaging Weight	121.3 lbs. / 55 kgs.
Dimensions	21.3" x 22" x 33" / 540 x 559 x 838mm
Packaging Dimensions	23" x 24" x 36" / 584 x 610 x 914mm
Item Number	37865

The technical data and performance index listed above should be used for reference only. They are subject to change.

*The actual quantity of ice produced per day can vary with room and water conditions.

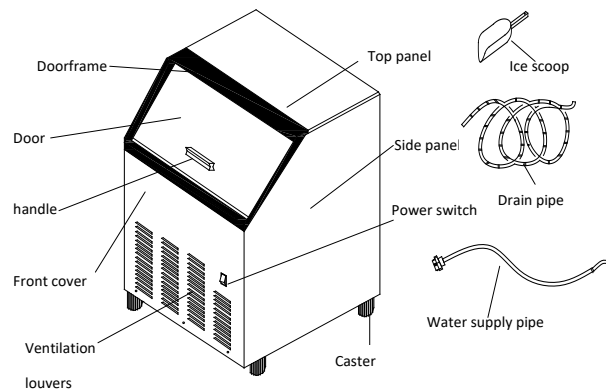

UNPACKING

WARNING

Excessive Weight Hazard

Use two or more people to move and install icemaker.
Failure to do so can result in back or other injury.

Remove Packaging Materials

IMPORTANT: Do not remove any permanent instruction labels or the data label on your ice maker.

Remove tape and glue from your ice maker before using.

- To remove any remaining tape or glue, rub the area briskly with your thumb. Tape or glue residue can also be easily removed by rubbing a small amount of liquid dish soap over the adhesive with your fingers. Wipe with warm water and dry.
- Do not use sharp instruments, rubbing alcohol, flammable fluids, or abrasive cleaners to remove tape or glue. These products can damage the surface of your ice maker.

Cleaning before use

After you remove all of the packaging materials, clean the inside of your ice maker before using it. See the “Interior cleaning” in the Cleaning and Maintenance section.

LOCATION REQUIREMENTS

INSTALLATION CLEARANCES:

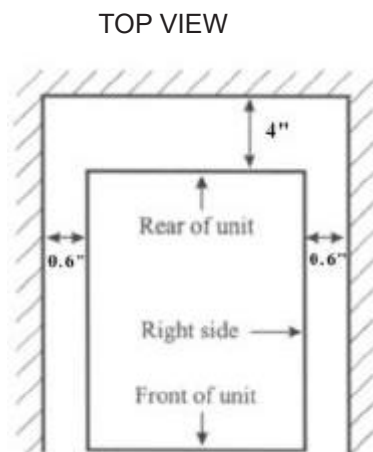

SIDE VIEW

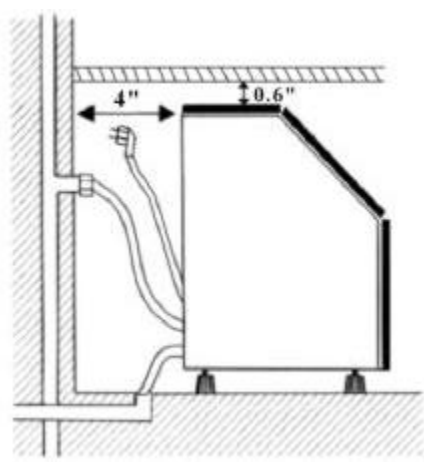

- To ensure proper ventilation for your ice maker, the front of the unit must be completely unobstructed. Allow more than 4" clearance at rear, 0.6" at top and sides for proper air circulation. The installation should allow the ice maker to be pulled forward for servicing if necessary.

Installation

- Choose a well ventilated area with temperatures above 50°F and below 100°F. This unit **MUST** be installed in an area protected from the elements, such as wind, rain, water spray or drips.
- Ice maker should not be located next to ovens, grills or other high heat resources.
- Installation of the ice maker requires a cold water supply inlet of 3/4" soft copper tubing with a shut-off valve and a gravity-drain system.
- The ice maker requires a continuous water supply with a minimum pressure of 15psi and a static pressure not to exceed 80psi. The temperature of the water feeding into the ice maker should be between 41°F and 90°F for proper operation.

WARNING

Normal operating ambient temperature should be between 50°F to 100°F. Normal operating water temperature should be between 41°F and 90°F. Operation of the icemaker for extended periods out side of these normal temperature ranges may affect production capacity.

- In general, it is always a good idea to filter the water. A water filter, if it is of the proper type, can remove taste and odors as well as particles. Where water is very hard, softened water may result in white, mushy cubes that stick together. Deionized water is not recommend.
- The ice maker must be installed with all electrical, water and drain connections in accordance with all state and local codes.
- The unit should be located on a firm and level surface. It is important for the ice maker to be leveled in order to work properly.
- The plug must be accessible after installation.
- A standard electrical supply (115VAC, 60Hz, 15A), properly grounded in accordance with the National Electrical Code and local codes and ordinances, required.

IMPORTANT: Do not kink or pinch the power supply cord between the ice maker and wall.

LEVELING THE ICE MAKER



It is important for the ice maker to be leveled in order to work properly. It can be raised or lowered by rotating the plastic sheaths around each of the four rolling casters on the bottom of the machine. If you find that the surface is not level, rotate the casters until the ice maker becomes level. You may need to make several adjustments to level it. We recommend using a carpenter's level to check the machine. You will find that the casters make it easy for one person to move the machine. This is useful for cleaning and sanitizing the surface on which the ice maker is installed because it allows you to move the unit and have easy access to the surface to be cleaned.

Installation

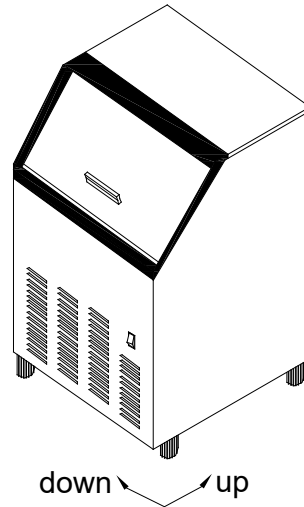
IMPORTANT: Once you are ready to install it in a cabinet or directly on the floor, you must adjust the feet to level the ice maker and lock the rollers. If the floor is level, just revolve the two front feet to touch the floor (See illustration).

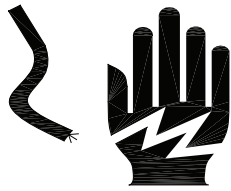

ELECTRICAL REQUIREMENTS

 DANGER 

<p>Electrical Shock Hazard</p> <p>Never remove the ground line.</p> <p>Never use an adapter.</p> <p>Never use an extension cord.</p> <p>Failure to follow these instructions can result in death, fire, or electrical shock.</p>

Before you move your ice maker into its final location, it is important to make sure you have the proper electrical connection: A standard electrical supply (115VAC, 60Hz.), properly grounded in accordance with the National Electrical Code and local codes and ordinances, required. It is recommended that a separate circuit, serving only your ice maker, be provided. Use a receptacle which cannot be turned off by a switch or pull chain.

Installation

WATER SUPPLY AND DRAIN CONNECTION

The water supply and drain should be roughed in and ready at the point of installation. A wall outlet directly behind the ice machine will make installation easier.

IMPORTANT:

1. All installations must be in accordance with local plumbing code requirements.
2. Make certain that the pipes are not pinched or kinked or damaged during installation.
3. Check for leaks after connection.

Tools required:

- Open-end wrenches.
- Phillips screwdriver.

Connecting the water line:

1. Find a 1/2 in. to 3/4 in. vertical cold water pipe near the installation location. The distance should be less than 6 feet. The water supply pipe provided with the ice maker is about 6 feet.
2. A shut-off valve must be installed to the main water supply.
3. Connect the water supply pipe to the tap, the other end connect with the water inlet valve tightly with hand.
4. Turn on main water supply and tap. Check for water supply connections leaks. Tighten any connections (including connections at the valve) or nuts that leak.

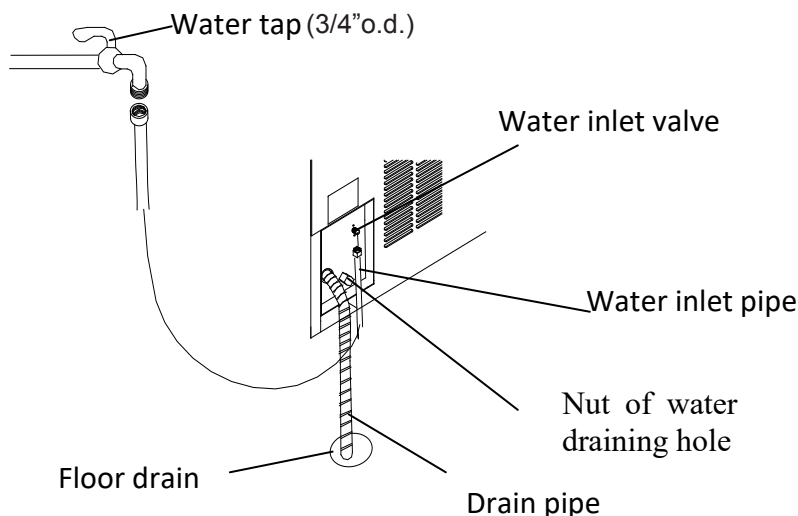

Connecting the drain line:

A gravity drain system is used in this type ice maker, drain water to the drain line through the provided drain water pipe with ice maker.

1. Find the floor drain near the ice maker. The distance should be less than 5 feet as the length of the long drain water pipe provided with the ice maker is about 5 feet.
2. Find the drain outlet on the back of ice maker. Connect one end of the long drain pipe to the drain outlet of the machine, the other end to the floor drain.

Installation

3. All horizontal run of drain lines must have a fall of ¼" per foot. An air gap will likely be required between the ice maker drain tube and the drain/waste receptacle. A stand pipe with a trap below it would be acceptable for the drain/waste receptacle.
4. Pour 1 gallon of water into the ice storage bin to check leaks at all drain connections and at the nut of the drain water hole. Tighten any connections or nuts that leak.

IMPORTANT: poor drainage will cause a high rate of ice melting in the ice storage bin.

INSTALLATION TYPES

This ice maker has been designed to be enclosed (as under a cabinet). It can also be free-standing or built-in (sealed to the floor). In every case, there must be adequate air space around the unit for ventilation purposes.

Enclosed Installation:

An enclosed installation will allow you to install the ice maker under a cabinet or in a kitchen cabinet provided the required clearance space around the ice maker is respected. You must follow the stated instructions for:

- Electrical requirements.
- Water supply.
- Leveling the ice maker.

Free-standing Installation:

The ice cube machine can be installed to be free-standing in any place you desire provided you have access to a water supply. This installation has the same requirements as an enclosed installation, plus you must also follow the stated instructions for:

- Electrical requirements.
- Water supply.
- Leveling the ice maker.

Built-in Installation:

If this method of installation is chosen, it will still be necessary to allow adequate ventilation space around the unit. The following additional items must be observed.

1. Place the ice maker in front of the installation location. Remove the feet and place the machine on the floor or on a platform depending on your installation requirements.
2. The water supply line must be plumbed before connecting to the ice maker.
3. Turn on the main water supply and tap. Check for water supply connection leaks. Tighten every connection (including connections at the water inlet).
4. If the electrical outlet for the ice maker is behind the cabinet, plug in the ice maker.
5. Push the ice maker into position.
6. Seal all around the cabinet to the floor with an approved caulking compound.

Operation

FINAL CHECK LIST BEFORE OPERATION

1. Have all packing materials and tape been removed from the interior and exterior of the ice maker?
2. Do you clean the ice storage bin?
3. Have the installation instructions been followed, including connecting the machine to water, drain and electricity?
4. Has the machine been leveled?
5. Is the ice maker in a site where the ambient temperature is within 50°F to 100°F and the water temperature within 41°F - 90°F all year around?
6. Has the water supply pressure been checked to ensure a minimum of 15psi and a static pressure not to exceed 80psi?
7. Is there a clearance of at least 4 in. at the rear, and 0.6 in. at the sides and top for proper air circulation?
8. Has the power supply voltage been checked or tested against the nameplate rating? And has a proper earth been installed in the ice maker?
9. Is the ice maker plug in?
10. Do you turn on the main water supply and the tap?
11. Do you check leaks to all water supply and drain pipe connections?

OPERATING METHOD

1. Switch on the power switch on the right side panel. The light will be on. The ice maker will start working automatically and feeding water.
2. After the first feeding of the water, the machine will automatically go to the ice-making stage, and the sound of water spraying will be heard.
3. Ice will automatically harvest to the ice storage bin.
4. When ice collected in the bin more quantity to cover the ice-full sensor. The ice maker will stop working. When you take away some ice make the sensor free, it will restart to make ice.

IMPORTANT:

- Although the unit has been tested at factory, due to long-time transit and storage, the first batch of cubes must be discarded.
- Never turn the water supply tap off when the ice maker is working.

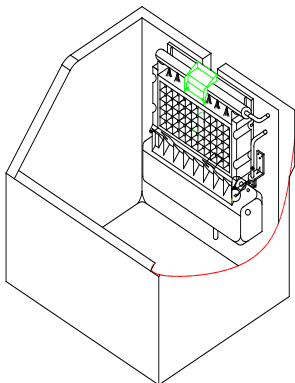

Ice making stage

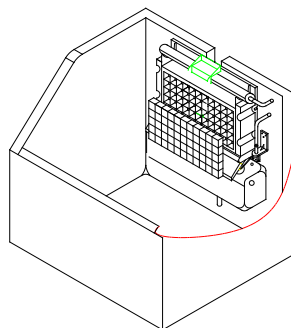

Ice harvest stage

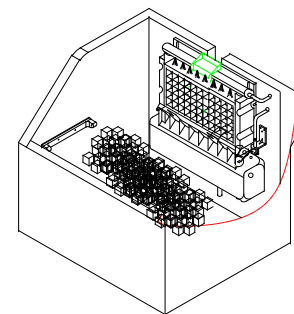

Ice full stage

HOW THE MACHINE MAKES ICE

There are two distinct cycles: freeze and harvest. The freeze cycle happens when water is flow to the evaporator surface. The harvest cycle is when the ice is released and water enters the machine. A complete cycle takes about 20 minutes.

Freeze: During the freeze cycle the compressor is pumping refrigerant, the fan motor is blowing air, and the water pump is circulating water. When the evaporator surface gets setting temperature, the ice maker will stop the freeze cycle and begin the harvest.

Harvest: During the harvest cycle the compressor is still operating, but the water pump have stopped. The hot gas valve have been energized; The valve open and warm up the freezing surface, allowing the cubes to fall into the bin. The freeze cycle will restart.

HOW ADJUST THE SIZE OF ICE CUBES

1. Press and hold the “Adjust” button for at least 3 seconds. The unit will enter the Ice Size Adjustment mode. The “ICE Making” LED (green) will be blinking continuously during the ice size adjustment. Release the button when the LED blinks continuously to adjust the ice size.
2. While in the Ice Size Adjustment mode, press the “Clean” button or the “Mode” button for the desired ice size.

Smaller ice setting:

By pressing the “Clean” button, you can decrease the size of the ice cubes. The “ICE FULL” LED (red) will flash as you lower the ice size and will finally be blinking at the setting of smallest ice size.

Larger ice setting:

By pressing the “Mode” button, you can increase the size of the ice cubes. The “ICE HARVEST” LED (yellow) will flash as the larger size is set and will blink when the setting of largest ice size has been reached.

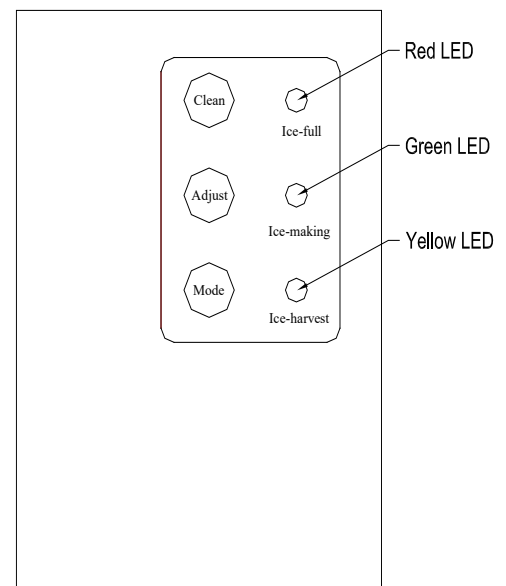

After 10 seconds without any operation, the unit will automatically memorize the current state and return to the previous mode.

NOTE:

- If during the ice size adjustment mode the “ICE FULL”, “ICE MAKING” and “ICE HARVEST” LEDs blink all at once, this indicates that the unit is in the regular (middle) setting of the ice size.
- When the machine is in the cleaning stage or ice full stage, the ice size adjustment mode cannot be accessed.

Operation

HOW THE MACHINE USES THE WATER

The ice maker begins with a fixed charge of water that is contained in the water bin. As the water flows to the freezing evaporator surface, the part of water that does not contain mineral impurities will freeze and stick to the ice cube molds. The water containing impurities falls back into the water bin. Gradually, during the freezing portion of the ice making cycle, the water in the water bin will become highly concentrated with mineral impurities. During the ice making process, fresh water enters the water trough continuously as the water in the water trough is frozen continuously in the evaporator.

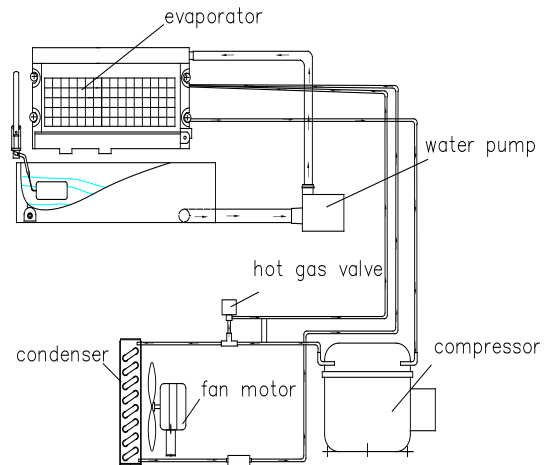

NORMAL SOUNDS

Your new ice maker may make sounds that are not familiar to you. Most of the new sounds are normal. Hard surfaces like the floor, walls can make the sounds seem louder than they actually are. The following describes the kinds of sounds that might be new to you and what may be making them.

- You will hear a swooshing sound when the water valve opens to fill the water bin for each cycle.
- Rattling noises may come from the flow of the refrigerant or the water line, Items stored on top of the ice maker can also make noises.
- The high efficiency compressor may make a pulsating or high-pitched sound.
- Water running from the water bin to the evaporator plate may make a splashing sound.
- Water running from the evaporator to the water bin may make a splashing sound.
- As each cycle ends, you may hear a gurgling sound due to the refrigerant flowing in your ice maker.
- You may hear air being forced over the condenser by the condenser fan.
- During the harvest cycle, you may hear the of ice cubes falling into the ice storing bin.
- When your first start the ice maker, you may hear water running continuously. The ice maker is programmed to run a rinse cycle before it begins to make ice.

PREPARING THE ICE MAKER FOR LONG STORAGE

If the ice maker is not used for a long time, or is to be moved to another place, it will be necessary to drain the system of water.

1. Shut off the water supply at the main water source.
2. Disconnect the water supply line from the water inlet valve.
3. Disconnect the drain pipe with the drain line of floor drain.
4. Allow the ice maker to run for an hour or more until all remaining ice cubes have been ejected from the ice maker assembly.
5. Shut off the electric supply at main electrical power source.
6. Screw off the nut of the water drain hole at the back of the machine, drain out water residue completely. (Do not loosen or screw off the nut at other times), then tighten the nut after finishing.
7. Drop the door open to allow for circulation and prevent mold and mildew.
8. Leave water supply line and power cord disconnected until ready to reuse.

CAUTION

If the icemaker is left unused for a long time, before the next use it must be thoroughly cleaned. Follow carefully any instructions provided for cleaning or use of sanitizing solution. Do not leave any solution inside the icemaker after cleaning.

Periodic cleaning and proper maintenance will ensure efficiency, top performance, and long life. The maintenance intervals listed are based on normal conditions. You may want to shorten the intervals if you have pets, the unit is used outdoors, or other special considerations.

What shouldn't be done

Never keep anything in the ice storage bin that is notice: objects like wine or beer bottles are not only unsanitary, but the labels may slip off and plug up the drain.

What should be kept clean

There are 4 things to keep clean:

1. The exterior.
2. The condenser.
3. The interior.
4. Water distribution tube.

WARNING

Before proceeding with cleaning and maintenance operations, make sure the power line of the unit is disconnected and the water line is shut off (EXCEPTION: icemaker system's cleaning)

EXTERIOR CLEANING

The door and cabinet may be cleaned with a mild detergent and warm water solution such as 1 ounce of dish washing liquid mixed with 2 gallons of warm water. Do not use solvent based or abrasive cleaners. Use a soft sponge and rinse with clean water. Wipe with a soft clean towel to prevent water spotting. Stainless steel models can discolor when exposed to chlorine gas and should be cleaned. Clean stainless steel models with a mild detergent and warm water solution and a damp cloth. Never use abrasive cleaning agents.

NOTICE: Stainless steel models exposed to chlorine gas and moisture, such as areas with spas or swimming pools, may have some discoloration of the stainless steel. Discoloration from chlorine gas is normal.

Maintenance

CONDENSER CLEANING

A dirty or clogged condenser prevents proper airflow, reduces ice making capacity, and causes higher than recommended operating temperatures that may lead to component failure. Have the condenser cleaned at least once every three months.

1. Unplug the ice maker or disconnect power.
2. Remove the 3 screws at the bottom of the front cover. Grasp the lower edge of the front cover at the right and left sides, raise it a little then pull down.

Note: Do not use too much force, as the wire leads connected to the power switch can be inadvertently disconnected.

3. Locate the condenser surface. Remove dirt and lint from the condenser fins and the unit compartment with a brush attachment on a vacuum cleaner.
4. Reassembly the front cover.
5. Plug in the ice maker or reconnect power.

WARNING

DO NOT touch the condenser fins. The condenser fins are sharp and can be easily damaged.

INTERIOR CLEANING

The ice storage bin should be sanitized occasionally. Clean the bin before the ice maker is used first time and reused after stopping some period. It is usually convenient to sanitize the bin after the ice making system has been cleaned, and the storage bin is empty.

1. Disconnect power to the unit.
2. Open the door and with a clean cloth, wipe down the interior with a sanitizing solution made of 1 ounce of household bleach or chlorine and 2 gallons of hot water (95°F to 115 °F).
3. Rinse thoroughly with clear water. The waste water will be drained off through the drain pipe.
4. Reconnect power to the unit.

The ice scoop should be washed regularly, wash it just like any other food container.

WARNING

DO NOT use solvent-based cleaning agents or abrasives on the interior. These cleaners may transmit taste to the ice cubes, or damage or discolor the interior.

WATER DISTRIBUTION TUBE CLEANING

When you find that the ice cubes are incompletely formed or the output of ice cubes is low, the water distribution tube may be blocked. Set the power switch to OFF. Unscrew the six screws holding the top panel and remove the panel. You will see the water distribution tube. Rotate the water distribution tube so that the holes in it are facing up. Using a toothpick or similar tool, dredge the holes, then rotate the water distribution tube back to its original position. If the tube is badly blocked, clean it as follows:

1. Shut off the water and power supplies.
2. Disconnect the water hose from the distribution tube.
3. Lift one side, remove the distribution tube.
4. With a brush, clean the tube with a dilute solution of warm water and a mild detergent such as dish washing liquid. After removing the dirt and lint from the surface, rinse the tube with clean water.
5. Replace the distribution tube.
6. Reconnect the water supply and power supply lines.
7. Re-attach the top panel.

ICE-MAKING SYSTEM CLEANING

Minerals that are removed from water during the freezing cycle will eventually form a hard, scaly deposit in the water system. Cleaning the system regularly helps remove the mineral scale buildup. How often you need to clean the system depends on how hard your water is or how effective your filtration may be. With hard water of 15 to 20 grains/ gallon (4 to 5 grains/liter), you may need to clean the system as often as every 3 months.

1. Set the power switch to OFF.
2. Remove all ice cubes from the storage bin.
3. Remove the screws in the front cover, push forward to remove the front cover. Locate the control box.
4. Keep the ice maker connected to the water supply. Pour 8 oz. of Nickel-Safe Ice Maker Cleaner Solution into the water tank.
5. Turn the power switch ON. Within 3 minutes, press the CLEAN button. The machine will run the Automatic Clean mode. The green Ice Making and the yellow Ice harvest LEDs will blink.
6. The cleaning cycle will continue for 30 minutes unless you press the power switch (you can press the power switch to stop the cleaning cycle any time during the 30 minutes). After cleaning, the green Ice Making and yellow Ice Harvest LEDs go on steady and the machine returns to Stand-by mode.
7. The dirty water must be drained out completely. Perform steps 2 and 3 in the Interior Cleaning section.
8. Repeat steps 4 to 6 above three times to rinse the ice-making system completely.
NOTE: Do not add Ice Maker Cleaner Solution to the water trough during the rinses.
9. Reassemble the front cover.
10. If you want to make ice cubes after cleaning, turn off the power switch, drain off the waste water, then turn on the power switch. The next ice-making cycle will begin.
11. Discard the first batch of ice.

SANITIZING THE ICE-MAKING SYSTEM

1. Set the power switch to OFF.

Maintenance

2. Remove all ice cubes from the storage bin.
3. Remove the screws in the front cover, push forward to remove the front cover. Locate the control box.
4. Prepare a sanitizing solution by mixing 1 oz. household bleach with 1 gallon of warm water.
5. Keep the ice maker connected to the water supply. Fill the water tank with the sanitizing solution.
6. Turn the power switch ON. Within 3 minutes, press the CLEAN button. The machine will run the Automatic Clean mode. The yellow Ice Harvest and the red Bin Full LEDs will blink.
7. The cleaning cycle will continue for 30 minutes unless you press the power switch (you can press the power switch to stop the cleaning cycle any time during the 30 minutes). After cleaning, the yellow Ice Harvest and the green Ice Making LEDs go on steady and the machine returns to Stand-by mode.
8. The dirty water must be drained out completely. Perform steps 2 and 3 in the Interior Cleaning section.
9. Repeat steps 5 to 8 above three times with fresh water to rinse the ice-making system completely.
NOTE: Do not add any cleaning or sanitizing solution to the water trough during the rinses.
10. Reassemble the front cover.
11. If you want to make ice cubes after cleaning, turn off the power switch, drain off the waste water, then turn on the power switch. The next ice-making cycle will begin.
12. Discard the first batch of ice.

WARNING

The ice machine cleaner contains acids.

DO NOT use or mix with any other solvent-based cleaner products.

Use rubber gloves to protect hands. Carefully read the material safety instructions on the container of the ice machine cleaner.

DISCARD the first batch of ice produced after cleaning.

Troubleshooting

BEFORE CALLING FOR SERVICE

If the unit appears to be malfunctioning, read through the OPERATION section of this manual first. If the problem persists, check the TROUBLESHOOTING GUIDE on the following pages. The problem could be something very simple which can be solved without a service call.

Troubleshooting

TROUBLESHOOTING GUIDE

Problem	Possible Cause	Probable Correction
The machine doesn't operate.	The ice maker is unplugged.	Plug in the ice maker.
	The fuse is blown.	Replace the fuse. Call for service to check for a short circuit in the ice maker.
	The ice maker power switch turn to OFF.	Turn the ice maker power switch to ON.
	The ice storage bin is full of ice.	Take away the ice, make sure that the ice-full sensor is free of ice.
The water doesn't feed in after the ice maker starts.	The water supply tap is turn off.	Turn on the water supply tap.
	The water supply pipe is not properly connected.	Reconnect the water supply pipe.
The machine makes ice, but bin does not fill up.	The condenser may be dirty.	Clean the condenser.
	The bin drain may be partially restricted.	Clean out the drain, check the installation.
	The air flow to the ice maker may be obstructed.	Check the installation.
	The ambient temperature and water temperature are high, or it is near with some other heat source.	Check the installation.
Water is leaking out of the unit.	Some water drops to the floor when you open the door to take out ice from ice storage bin.	Normal condensation on the door or some water together with ice. Take care when you take out ice.
	Water supply connection leaking.	Tighten fitting. See "Connecting the Water Line".
	Nut of the water drain hole leaking.	Tighten fitting. See "Connecting the Water Line".
	Drain pipe connection leaking.	Tighten fitting. See "Connecting the Drain".
Cubes are partially formed--are white at the bottom.	Not enough water in the water bin.	Check if the water supply pressure is below 15psi.
		Check water supply--filter may be restricted.
		Check for a water leak at the water bin.
		Check water inlet valve may be restricted.

Troubleshooting

Noise during operation.	The feet are not leveled and locked.	Level and lock the feet. See Leveling the Ice Maker.
	Certain sounds are normal.	See Normal Sounds.
The ice maker stops suddenly while making ice.	The electricity is off.	Reconnected the power supply line.
	The room temperature is out the state range.	Cut off the electricity, let the ice maker stop working till the temperature returns within the stated range.
The body of the ice maker is electrified.	The ground line isn't in the socket.	Please use the socket meeting the standard.
Scales occur frequently inside the machine.	The rigidity of the water quality is too high.	Use a water-soften apparatus installed in front of the water inlet valve.
The ice cubes are incomplete while being dumped.	The sprinkler is blocked.	Clean it see "interior cleaning".

Parts Breakdown

Model IC-CN-0016 37865

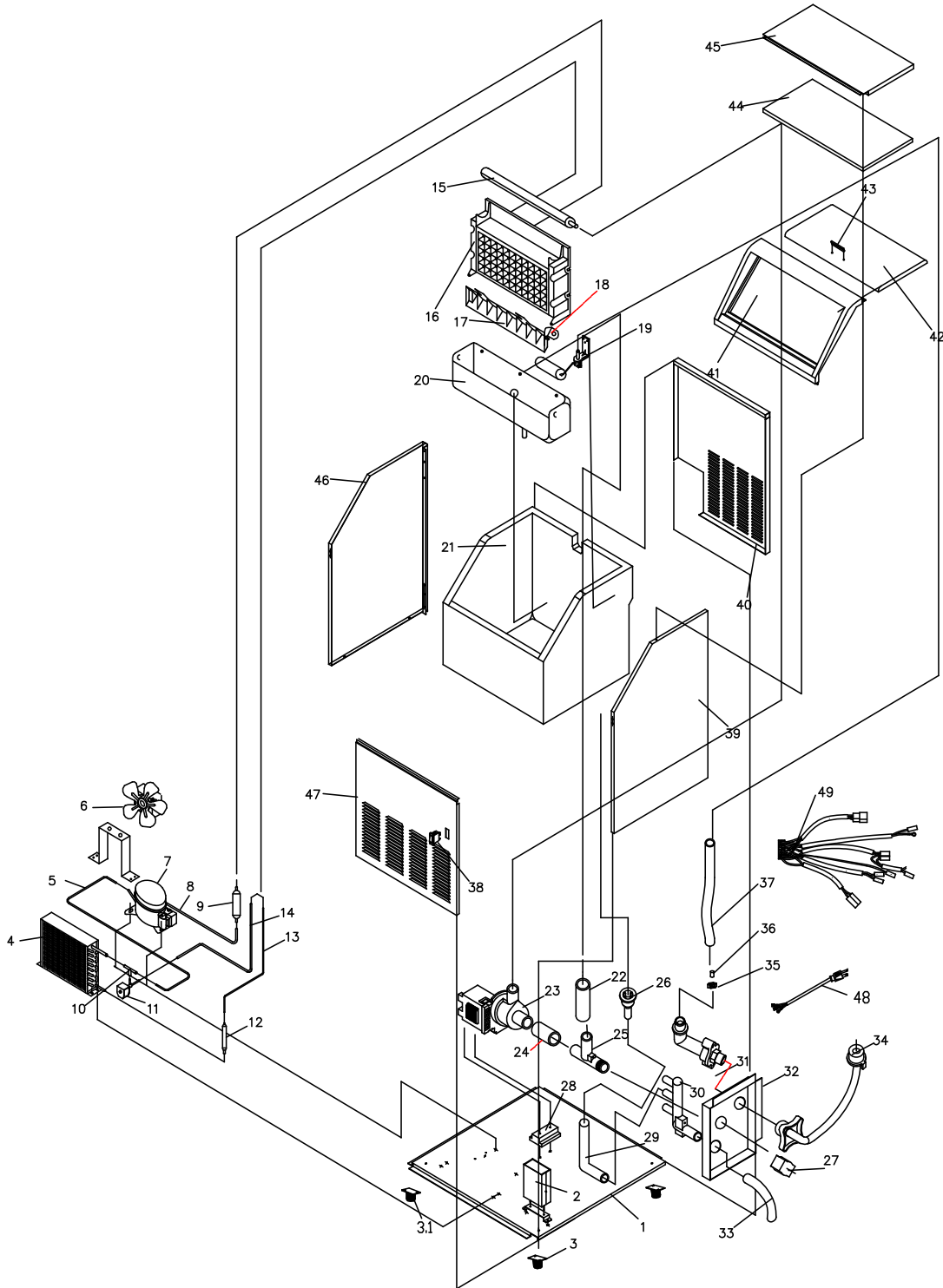

Parts Breakdown

Model IC-CN-0016 37865

Item No.	Description	Position	Item No.	Description	Position	Item No.	Description	Position
70009	Controller Box for 37865	2	70018	Ice Full Probe for 37865	18	70030	Drain Pipe for 37865	33
70010	Left Foot for 37865	3	70019	Storage Bin for 37865	21	70031	Water Supply Pipe for 37865	34
70011	Right Foot for 37865	3.1	70020	Water Trough Outlet Hose for 37865	22	70032	Nut of Water Inlet Pipe for 37865	35
70012	Condenser for 37865	4	39285	Water Pump for 37865	23	70033	Supporting Pipe for 37865	36
39284	EBM Motor 10W for 37865	6	70022	Water Pump Inlet Hose for 37865	24	70034	Water Inlet Hose for 37865	37
70014	Compressor for 37865	7	70023	Multi-Connection Pipe for 37865	25	70035	Power Switch for 37865	38
39282	Hot Gas Valve Coil for 37865	11	70024	Downcomer for 37865	26	70036	Doorframe for 37865	41
39281	Hot Gas Valve Body for 37865	11.1	70025	Cap Nut of Water Drain for 37865	27	70037	Door for 37865	42
40286	Drier for 37865	12	70026	Pump Mat for 37865	28	70038	Handle for 37865	43
70016	Capillary Tube for 37865	13	70027	Rubber of Drain for 37865	29	70039	Power Supply and Plug for 37865	48
70017	Evaporator for 37865	16	70028	Connector of Drain for 37865	30	70040	Wiring for 37865	49
64161	Evaporator Flap for 37865	17	70029	Water Inlet Connector for 37865	31			

Electrical Schematics

Model IC-CN-0016 37865

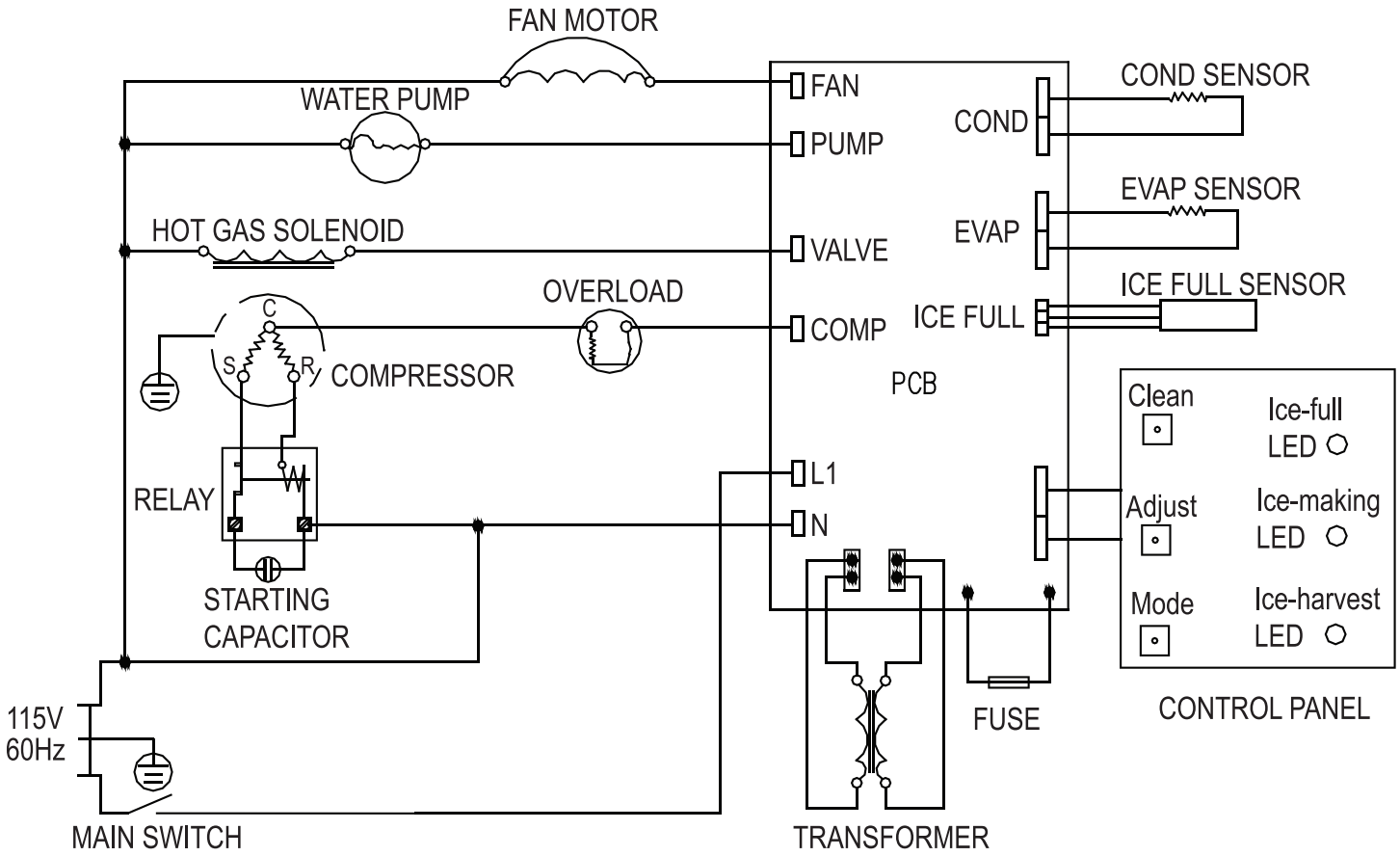



Warranty Registration

Thank you for purchasing an Omcan product. To register your warranty for this product, complete the information below, tear off the card at the perforation and then send to the address specified below. You can also register online by visiting:

Merci d'avoir acheté un produit Omcan. Pour enregistrer votre garantie pour ce produit, complétez les informations ci-dessous, détachez la carte au niveau de la perforation, puis l'envoyer à l'adresse spécifiée ci-dessous. Vous pouvez également vous inscrire en ligne en visitant:

Gracias por comprar un producto Omcan usted. Para registrar su garantía para este producto, complete la información a continuación, cortar la tarjeta en la perforación y luego enviarlo a la dirección indicada a continuación. También puede registrarse en línea en:

<https://omcan.com/warranty-registration/>

For mailing in Canada

Pour postale au Canada

Por correo en Canadá

OMCAN

PRODUCT WARRANTY REGISTRATION

3115 Pepper Mill Court,

Mississauga, Ontario

Canada, L5L 4X5

For mailing in the US

Pour diffusion aux États-Unis

Por correo en los EE.UU.

OMCAN

PRODUCT WARRANTY REGISTRATION

4450 Witmer Industrial Estates, Unit 4,

Niagara Falls, New York

USA, 14305

or email to: service@omcan.com



Purchaser's Information

Name: _____

Address: _____

City: _____ Province or State: _____ Postal or Zip: _____

Country: _____

Dealer from which Purchased: _____

Dealer City: _____ Dealer Province or State: _____

Invoice: _____

Model Name: _____ Model Number: _____

Machine Description: _____

Date of Purchase (MM/DD/YYYY): _____

Would you like to extend the warranty? Yes No

Company Name: _____

Telephone: _____

Email Address: _____

Type of Company:

Restaurant Bakery Deli

Butcher Supermarket Caterer

Institution (specify): _____

Other (specify): _____

Serial Number: _____

Date of Installation (MM/DD/YYYY): _____

Thank you for choosing Omcan | Merci d'avoir choisi Omcan | Gracias por elegir Omcan



Since 1951 Omcan has grown to become a leading distributor of equipment and supplies to the North American food service industry. Our success over these many years can be attributed to our commitment to strengthen and develop new and existing relationships with our valued customers and manufacturers. Today with partners in North America, Europe, Asia and South America, we continually work to improve and grow the company. We strive to offer customers exceptional value through our qualified local sales and service representatives who provide convenient access to over 6,500 globally sourced products.

Depuis 1951 Omcan a grandi pour devenir un des “leaders” de la distribution des équipements et matériel pour l’industrie des services alimentaires en Amérique du Nord. Notre succès au cours de ces nombreuses années peut être attribué à notre engagement à renforcer et à développer de nouvelles et existantes relations avec nos clients et les fabricants de valeur. Aujourd’hui avec des partenaires en Amérique du Nord, Europe, Asie et Amérique du Sud, nous travaillons continuellement à améliorer et développer l’entreprise. Nous nous efforçons d’offrir à nos clients une valeur exceptionnelle grâce à nos ventes locales qualifiées et des représentants de service qui offrent un accès facile à plus de 6500 produits provenant du monde entier.

Desde 1951 Omcan ha crecido hasta convertirse en un líder en la distribución de equipos y suministros de alimentos en América del Norte industria de servicios. Nuestro éxito en estos años se puede atribuir a nuestro compromiso de fortalecer y desarrollar nuevas relaciones existentes con nuestros valiosos clientes y fabricantes. Hoy con socios de América del Norte, Europa, Asia y América del Sur, que trabajan continuamente para mejorar y crecer la empresa. Nos esforzamos por ofrecer a nuestros clientes valor excepcional a través de nuestro local de ventas y representantes de los servicios que proporcionan un fácil acceso a más de 6,500 productos con origen a nivel mundial.

